

# GEHLER

## SANITÄRSYSTEME

# DUSCHRINNE LÄNGE WET ROOM CHANNEL DOUCHE à L'ITALIENNE RIGOLE PENTRU DUS

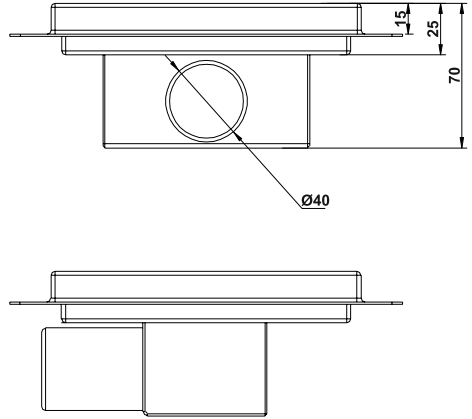
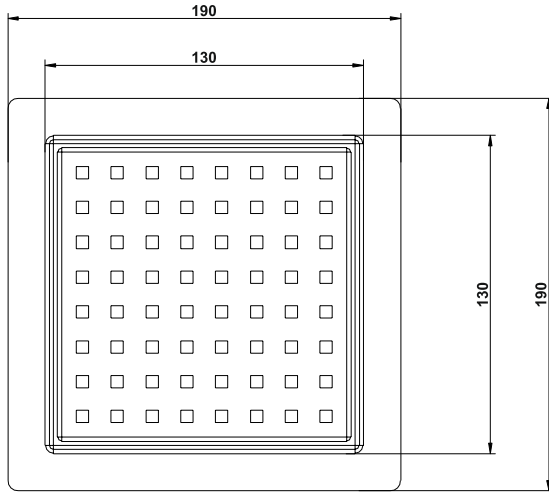

## Edelstahl 304 S/S 304 Acier inoxydable 304

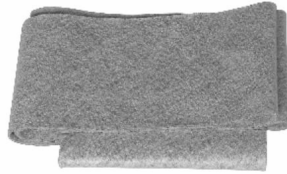

Packungsinhalt: syphon + filter, Wasserdichtes tuch, Verzinkte stahlgriff

Package contents: syphon + filter, waterproof membrane, galvanized steel handle

Contenu du colis: syphon + filtre, tissu imperméable à l'eau, poignée en acier galvanisé

Pachetul include: sifon si element de filtrare, membrana hidrofuga, cheie galvanizata



QUADRAT  
SQ-01



DURANTE  
SQ-02



ONDA  
SQ-03



VOLTA  
SQ-05



PIEDRA  
SQ-T

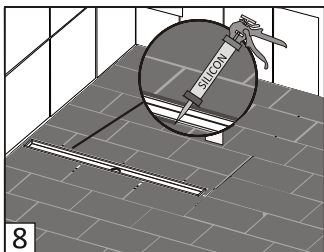
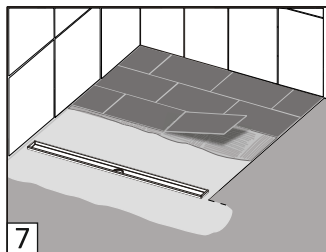
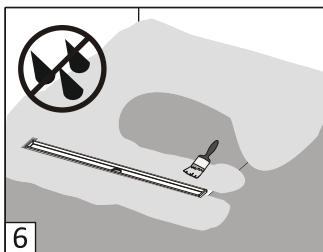
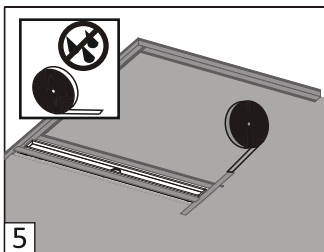
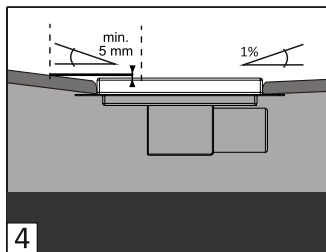
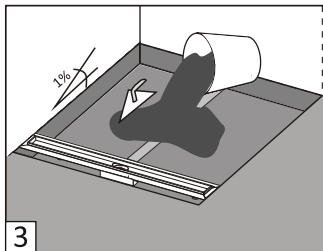
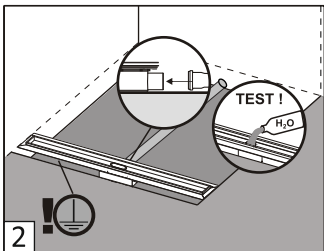
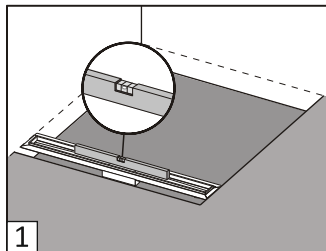

### REINIGUNG UND INSTANDHALTUNG

Edelstahl ist anfällig für Kratzer. Zur Reinigung verwenden Sie keine scharfen oder scheuernden Materialien. Verwenden Sie gemeinsame Haushaltsreiniger für das Bad oder spezielle Reinigungsmittel für Edelstahl. Die Duschrinne erfordert keine besondere Wartung, aber wir empfehlen, regelmäßig um den Abfall zu reinigen Teil innen und entfernen Sie alle möglichen Verunreinigungen.

### CLEANING AND MAINTENANCE

Stainless steel is vulnerable to scratches. When cleaning, do not use sharp or abrasive materials. Use common household detergents for bathroom or special cleaning agents for stainless steel. The shower drain does not require any special maintenance, but we recommend to regularly clean the waste part inside and remove any possible impurities.

### NETTOYAGE ET ENTRETIEN

L'acier inoxydable est vulnérable aux rayures. Lors du nettoyage, ne pas utiliser des matériaux pointus ou abrasifs. Utilisez les détergents ménagers communs pour salle de bains ou de nettoyage spécial des agents pour l'acier inoxydable.

Le drain de la douche ne nécessite pas d'entretien particulier, mais il est recommandé de nettoyer régulièrement la partie des déchets à l'intérieur et éliminer toutes les impuretés possibles.

### CURATARE SI INTRETINERE

Oțelul inoxidabil este vulnerabil la zgârieturi. Nu folosiți materiale ascuțite sau abrazive. Utilizați detergenți de uz casnic comuni sau soluții speciale pentru oțel inoxidabil.

Scurgerea nu necesită întreținere specială, dar vă recomandăm să o curățați în mod regulat și să îndepărtați impuritățile posibile.